

Automatic Structure Synthesis for 3D Woven Relief

RUNDONG WU, Cornell University, USA
CLAIRE HARVEY, T.E.A.M. Inc., USA
JOY XIAOJI ZHANG, Cornell University, USA
SEAN KROZNER, T.E.A.M. Inc., USA
BROOKS HAGAN, Rhode Island School of Design, USA
STEVE MARSCHNER, Cornell University, USA

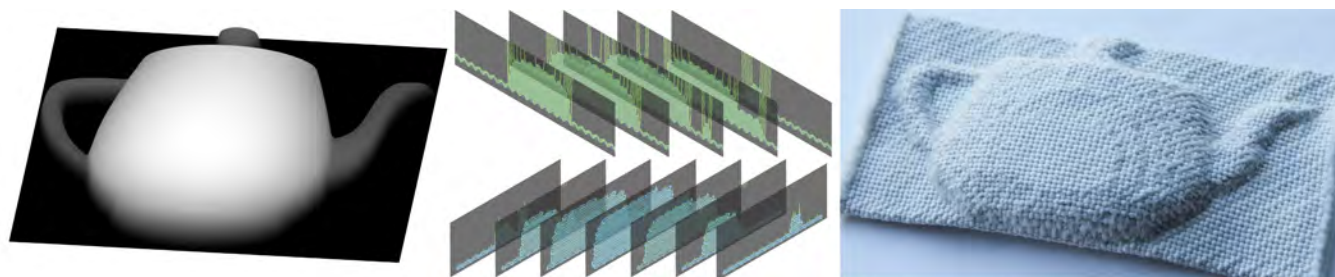

Fig. 1. Given a height field (left), our method automatically generates a 3D weavable structure (middle, showing slices of cutting planes intersecting with the model) including both warp (green) and weft (blue) paths, which can be fabricated on a Jacquard loom to approximate the input shape (right).

3D weaving is a manufacturing technique that creates multilayer textiles with substantial thickness. Currently, the primary use for these materials is in regularly structured carbon-polymer or glass-polymer composites, but in principle a wide range of complex shapes can be achieved, providing the opportunity to customize the fiber structure for individual parts and also making 3D weaving appealing in many soft-goods applications. The primary obstacle to broader use is the need to design intricate weave structures, involving tens to hundreds of thousands of yarn crossings, which are different for every shape to be produced. The goal of this research is to make 3D weaving as readily usable as CNC machining or 3D printing, by providing an algorithm to convert an arbitrary 3D solid model into machine instructions to weave the corresponding shape. We propose a method to generate 3D weaving patterns for height fields by slicing the shape along intersecting arrays of parallel planes and then computing the paths for all the warp and weft yarns, which travel in these planes. We demonstrate the method by generating weave structures for different shapes and fabricating a number of examples in polyester yarn using a Jacquard loom.

CCS Concepts: • **Computing methodologies** → **Shape modeling**;

Additional Key Words and Phrases: Fabrication, 3D Weaving

Authors' addresses: Rundong Wu, Cornell University, Ithaca, USA; Claire Harvey, T.E.A.M. Inc. Woonsocket, USA; Joy Xiaoji Zhang, Cornell University, Ithaca, USA; Sean Kroszner, T.E.A.M. Inc. Woonsocket, USA; Brooks Hagan, Rhode Island School of Design, Providence, USA; Steve Marschner, Cornell University, Ithaca, USA.

Permission to make digital or hard copies of all or part of this work for personal or classroom use is granted without fee provided that copies are not made or distributed for profit or commercial advantage and that copies bear this notice and the full citation on the first page. Copyrights for components of this work owned by others than the author(s) must be honored. Abstracting with credit is permitted. To copy otherwise, or republish, to post on servers or to redistribute to lists, requires prior specific permission and/or a fee. Request permissions from permissions@acm.org.

© 2020 Copyright held by the owner/author(s). Publication rights licensed to ACM.
0730-0301/2020/7-ART102 \$15.00
<https://doi.org/10.1145/3386569.3392449>

ACM Reference Format:

Rundong Wu, Claire Harvey, Joy Xiaoji Zhang, Sean Kroszner, Brooks Hagan, and Steve Marschner. 2020. Automatic Structure Synthesis for 3D Woven Relief. *ACM Trans. Graph.* 39, 4, Article 102 (July 2020), 10 pages. <https://doi.org/10.1145/3386569.3392449>

1 INTRODUCTION

The traditional process of weaving is used to make textiles for a broad range of applications. The fabrics are typically 2D—they are thin in height compared to their width and length, and are therefore used as sheet material. With the advent of fiber-reinforced composites requiring thick volumes to be filled with fibers for strength, the process of 3D weaving has emerged. Using industrial looms with some modifications to the way yarns are supplied, 3D weaving produces fabrics up to dozens of layers thick, which are comparable to their other dimensions. Using 3D fabrics in composites comes with advantages in strength and durability compared to a stack of separate layers, which is weak in the thickness direction and prone to delamination.

For reasonably flat shapes, 3D fabrics can be made in large uniform panels and bent to fit the shape of a part. For high-performance applications with complex geometry, however, the best solution is to use a “preform,” a fabric that is woven specially for the part, with a shape close to the desired final shape so that it easily deforms to fit and provides a uniform and well-aligned distribution of fibers throughout. The typical practice is to use preforms only for the most demanding applications, and the required weave structures are designed manually, with some low-level support from software tools, in a process requiring hours of design time and multiple weaving trials for every new part.

Designing 3D woven fabrics is complicated because the structures in which the yarns interlace need to be consistent and uniform in

the interior, while adapting at the surface in order to produce the right shape. Also, special consideration is needed at edges, corners, and steep slopes. While it is possible to handle all these concerns manually, with thousands of yarns and dozens of layers in even a small object, designing complex shapes is exceedingly tedious and error-prone.

The problem of designing complex shapes is an ideal one to solve computationally. If it were made easy, then not only could the properties of odd-shaped and unique parts made from fiber-reinforced composites be improved, but 3D weaving could be used to make many other products. For instance, recent research [Harvey et al. 2019] has demonstrated the feasibility of 3D woven footwear. And a range of soft goods including bags, backpacks and safety harnesses could be made with fewer pieces and improved functionality.

3D weaving resembles 3D printing in being an additive process. Another analogy is CNC machining, a manufacturing process where planning the manufacturing sequence is the major challenge in achieving good results. In both fields, automatic techniques have been developed that allow users to simply design the desired shapes as solid models, and the manufacturing sequence, tool path planning, and control code generation are all handled automatically.

The goal of this research is to achieve the same capability as 3D printing and CNC machining for 3D weaving, that is, to let a user start with a solid model and end up with a 3D woven object that has the desired shape, with the ability to fine-tune the material properties and surface treatment to a particular application. In this paper, we solve the first step towards this goal: we present a system that can 3D weave any height field, with some limitations on the slopes. Our approach is in some ways analogous to 3D printing: the solid shape is sliced into layers, and a path is planned for adding material to each layer. It is quite different, though, in that there are two orthogonal sets of layers to be designed, which must interlace in 3D to form a material that holds together, provide the right amount of material in the interior, and form a smooth finish on the surface. We achieve this using two separate algorithms for designing the lengthwise (warp) and crosswise (weft) slices, accounting for the very different physical constraints that the weaving process places on the yarns along the two directions.

2 RELATED WORK

2.1 3D Weaving

3D weaving refers to a wide range of woven textiles that take on substantial 3D form [Chen et al. 2011]. The most common application for 3D weaving is to create reinforcing fabrics for composites. Composites made with 3D wovens are used in many industries for their excellent mechanical properties. The advantages of 3D woven materials in this application include the flexibility to conform to curved surfaces during production and delamination resistance in the finished part provided by fibers aligned in the z-direction.

Various 3D woven structures exist aside from sheet materials. Spacer fabrics [Yip and Ng 2008] and tubular fabrics [Geerincx et al. 2016] can be made using repeating structures. Non-repeating structures are used to create simple shapes, such as T- or H- shaped beams [Umair et al. 2015] and cylinder or flange preforms [Mouritz et al. 1999]. These structures are all one-off constructions built as

card images (bit maps serving as machine instructions for the loom, see Section 3.2) with little software support.

2.2 Textile Design Software

Cloth designers use a set of commercial software packages to design structures for woven materials and create the card images.

Pointcarre [1988] is a proprietary system providing mature and flexible features for 2D weaving, with a focus on implementing complex patterns by substituting multiple weaves into the card image according to a graphic image. Since the substitution operates directly on the card image, it does not reason about the 3D structure or account for the compatibility of different 3D structures combined together. ScotWeave [2019] focuses on automating traditional drafting processes, in which the user can create a repeatable unit of weave structure in a slice view and produce the card image with the small scale unit tiled. However, it does not aim for creating complex spatially varying structures. EAT [2015] demonstrates a 2D and 3D design interface for creating 3D weaving structures manually. With MultiMech [2018] the user can use a menu with numbers to specify yarn topology and create small scale 3D weave structures, with a focus on simulating the resulting models. TexGen [Sherburn 2007] is an open-source system with basic structure editing ability, also with a focus on applying finite element simulation to the generated models. Zhang et al. [2010] demonstrated an interactive system for creating single-layer woven cloths on a multi-input device.

2.3 Textiles and Fabrication

Recent research in computer graphics and HCI shows interest in using textiles as a technique for fabricating soft 3D objects. Most works [Albaugh et al. 2019; Kaspar et al. 2019; McCann et al. 2016; Narayanan et al. 2018, 2019; Wu et al. 2019] focus on knitting, which can not only assemble sheets and tubes but also create complex 3D shapes by optimizing the knitting patterns. Other works such as [Peng et al. 2015] use another idea that cuts and glues sheets of fabrics to create 3D shapes. Another emerging direction is interactive smart textiles, which often embed electronic devices into woven or knitted materials to achieve certain functionalities [Friske et al. 2019; Poupyrev et al. 2016].

[Harvey et al. 2019] demonstrated a fully woven shoe designed manually. By carefully arranging different layers, structures and materials in the woven volume, both complex geometric shapes and functionality can be achieved for the woven objects. Such design, though, requests a lot of manual work and iterations.

2.4 Slicer and Path Planning for 3D Fabrication

The slicer is an essential software for 3D printing, which decomposes a 3D model into horizontal slices and generates the tool paths and machine instructions for each slice. In fused deposition modeling (FDM), the printer nozzle follows these paths and deposits materials layer by layer to fabricate the 3D object. Several open-source and commercial slicers such as Slic3r [2013] and Ultimaker Cura [2011] are available on the market.

Recent research shows interest in tool path generation and optimization for 3D printing. Zigzag paths [Ding et al. 2014] and spiral curves [Held and Spielberg 2014; Zhao et al. 2016] are often used

for filling the space. For a complicated 2D shape, a common practice is decomposing it into smaller domains and generate tool paths for each domain separately [Ding et al. 2014; Dwivedi and Kovacevic 2004; Held and Spielberger 2014; Zhao et al. 2016]. Optimization is often applied to create continuous and smooth paths. There is also an interest in representing or fabricating 3D shapes with simple primitives such as single triangle strip [Gopi and Eppstien 2004], chain [Yu et al. 2019], or geodesic foliations [Vekhter et al. 2019].

Our problem is similar to the slicing and path planning problem, but the nature of weaving makes yarn routing in the two axes (warp and weft) very different.

3 BACKGROUND

Woven cloth is formed by two sets of yarns, called the *warp* and the *weft*, which lie orthogonally and interlace to form a fabric. The most important factor in cloth structures is the yarn topology, that is, which warp yarns pass above or below which weft yarns. Therefore, the problem of designing a woven structure with N warp yarns, or *ends*, and M weft yarns, or *picks*, is reduced to defining an $N \times M$ binary image known in as the *card image*. Common 2D weave patterns such as plain weave or satin (Figure 4) weave produce a single-layer fabric with parallel yarns arranged side by side. However, with the appropriate card image, it is possible to stack the yarns vertically as well. Figure 2 demonstrates a simple example where the sequence of weft insertions illustrates how the raised and lowered warp ends guide the weft yarns into place and subsequently contain them in a stable structure.

In 3D weaving, the same idea is taken to the extreme in creating multilayer textiles that fill a 3D volume. As each weft yarn is inserted, the configuration of the raised and lowered warp ends guides the yarn into its place in the structure, and both warp and weft yarns can follow complicated paths through the resulting volumetric material.

3.1 Jacquard Loom

While repetitive structures can be woven on simple machines, more complex fabrics require weaving using Jacquard looms, where each

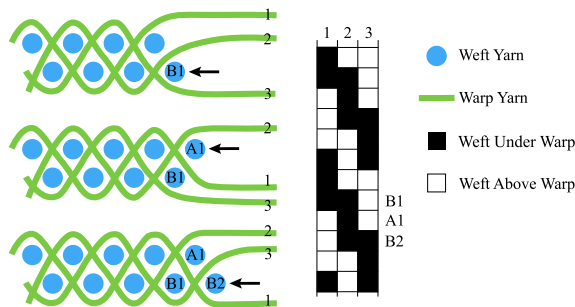

Fig. 2. By arranging the raised and lowered warp ends properly, weft yarns can be inserted to form a multi-layer structure. The card image shows three columns of a 2-layer 3-twill fabric, where each row corresponds to a weft insertion and each column corresponds to a warp yarn. Left is a side view of the weaving sequence for three successive weft insertions, corresponding to the three labeled rows in the card image. Each weft is guided to the top or bottom layer by the card image.

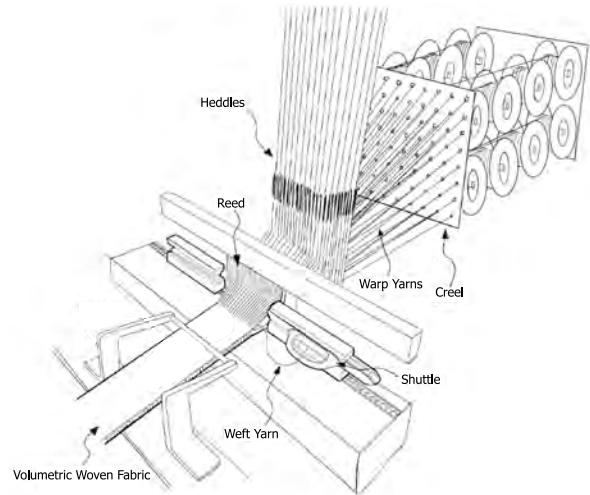

Fig. 3. Jacquard Loom

warp yarn is separately actuated under computer control, with no constraints on what card image can be used. The 3D woven samples in this paper are all fabricated using a Jacquard loom. The most relevant parts of the machine (Figure 3) are the Jacquard head mounted above the loom that is capable of pulling up any subset of the heddles which carry the warp yarns; the shuttle, which carries a spool of weft yarn back and forth to insert the yarn into the shed (the space between the raised and lowered warp yarns); and the reed, which presses the weft yarns into place after each insertion. There is a take-up mechanism that pulls the fabric forward at a defined rate as it is woven. For 3D weaving, the warp is set up differently than for ordinary weaving: rather than having all the warp yarns wrapped on a cylindrical beam so that they all unspool at the same rate, the warp yarns are supplied by individual spools in a *creel*, with a small constant tension maintained on each yarn individually. This means that yarns of varying lengths can be drawn in from different warp ends, which is generally required for complicated 3D patterns since the warp yarns may take very different paths and need different amounts of material to maintain proper tension.

The input to a Jacquard loom is a binary image as well as a number of parameters governing the speed of weaving and the rate at which material is taken up.

As with any other loom, the warp of a 3D weaving loom is arranged logically in a left-to-right sequence following the Jacquard mechanism, but in order to fit a large enough density of warp ends to produce the desired multilayer structures, the warp ends are organized into a grid of columns and layers. Each column consists of typically 8 to 32 warp yarns (specifically, our loom uses 24 warps per column), which all pass through a single opening in the reed and are placed at the same horizontal position.

In the weaving process, the shuttle passes back and forth through the shed, inserting the weft yarn into the fabric. Card images are normally applied to place groups of sequential weft insertions into stacks in the resulting fabric, using a generalization of the process illustrated in Figure 2.

3.2 Weave Structure and Card Image

The essence of designing a woven textile is to orchestrate the card image that will guide the weft and warp yarns into an arrangement that gives the resulting fabric the desired shape, appearance, and mechanical properties. Figure 4 shows several common weave patterns that are simulated using the simulator described in [Leaf et al. 2018] and corresponding card images. Plain weave is the most basic weave pattern, in which each weft yarn goes above one warp yarn and then under one warp yarn sequentially, corresponding to a checkerboard pattern in the card image. Satin weave is another common pattern in which the weft yarn passes over multiple yarns and then under one yarn. 3D weaving requires patterns that stack multiple layers of yarns to create a thick volume. Most often the weft yarns follow fairly straight paths, other than where they turn around, and the warp yarns travel up and down to interlace them. A number of structures are commonly used (Figure 4), differing in the steepness of the paths taken by the warp yarns and in how far up and down they travel. In this work, we use three representative patterns: two layer-to-layer patterns, in which warp yarns travel up and down just enough to hold each layer to the next, and one through-thickness pattern, in which every warp yarn travels all the way between the top and bottom surfaces. They are (see details in Section 4.3, Figure 11 and Figure 12):

- Plain layer-to-layer, which is similar to the plain weave pattern. Each warp yarn goes above and below two layers of weft yarns, alternating on every step.
- Angled layer-to-layer, in which each warp yarn goes above and below two layers of weft yarns, stepping one layer per step so that it takes four steps to repeat.
- Through-thickness angle interlock, in which warp yarns travel two layers per step all the way from front to back, then back to front, repeating after D steps, where D is the number of layers in the fabric.

Such patterns are widely used in traditional 3D weaving applications and are known to produce good results, but the thickness, softness and rigidity of the material are markedly different.

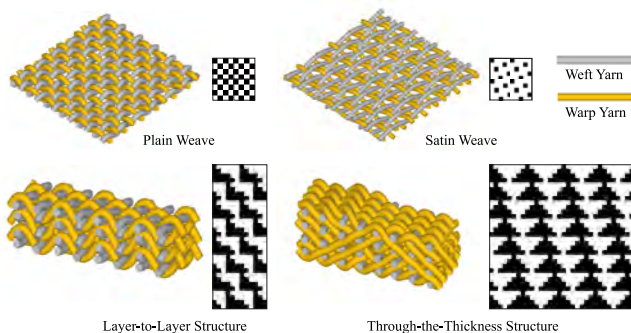

Fig. 4. Simulated Common Weave Structures and Card Images

As shown in Figure 4, the card image for 3D woven fabrics can be complicated. Designing an irregularly shaped object is a challenging task, because the designer needs to make the card image that controls every single warp-weft crossing, which may contain millions

of pixels. Usually, the designer draws the paths of the weft and warp yarns and translates them into a card image by noting whether each weft yarn passes above or below each warp yarn. Commercial software such as ScotWeave [2019] automates the translation of a small repeating unit of yarn paths into a card image, but the support for creating spatially varying shapes is minimal. Even if the card image translation is fully automated, designing yarn paths manually for the entire fabric is still complicated and tedious.

Our algorithm aims to fully automate this design process, focusing on creating samples that approximate arbitrary height fields. In Section 4, we will explain how our algorithm takes in a height field, generates the weaving structure, and exports the card image that can be woven on a loom.

3.3 Shuttle Weaving

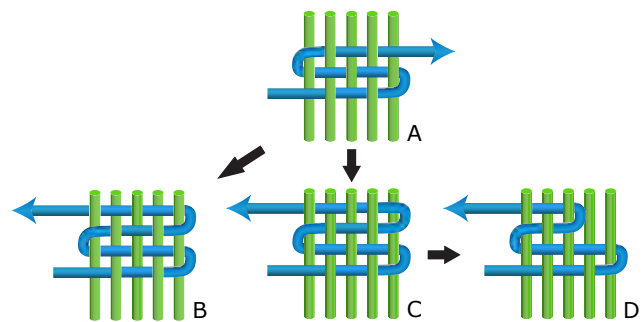

Fig. 5. **Weft Turnarounds:** In shuttle weaving the weft wraps around the first warp yarn it encounters that switches position between two consecutive picks, which can happen at the edge (Figure B) or interior (Figure D) of a fabric.

As described in Section 3.1, during weaving, the shuttle carries a continuous weft yarn that passes through the opening between the raised and lowered warp yarns. When the shuttle goes back in the opposite direction, the weft yarn will be caught by the first warp yarn it encounters that has switched position, creating a wraparound at that yarn. In ordinary weaving this wraparound happens at the edge of the fabric, but as illustrated in Figure 5, if the warp yarns at the edge do not change position, the weft will turn around at the first yarn that does. In 3D weaving it is useful to turn around inside the material, which enables creating varying numbers of layers in different parts of the fabric (See Section 4.2).

4 STRUCTURE SYNTHESIS

4.1 Overview

Figure 6 illustrates the pipeline of our approach: the material is structured on a grid of rows, columns, and layers, and we slice the height field denoted by the input surface along the plane of each row and each column and design yarn paths to fill the space below the surface. Given the different roles of weft and warp yarns as described in Section 3.1, the constraints on the weft and warp paths are quite different, so the algorithms for generating warp paths (Section 4.3) and weft paths (Section 4.2) are different. Each slice is

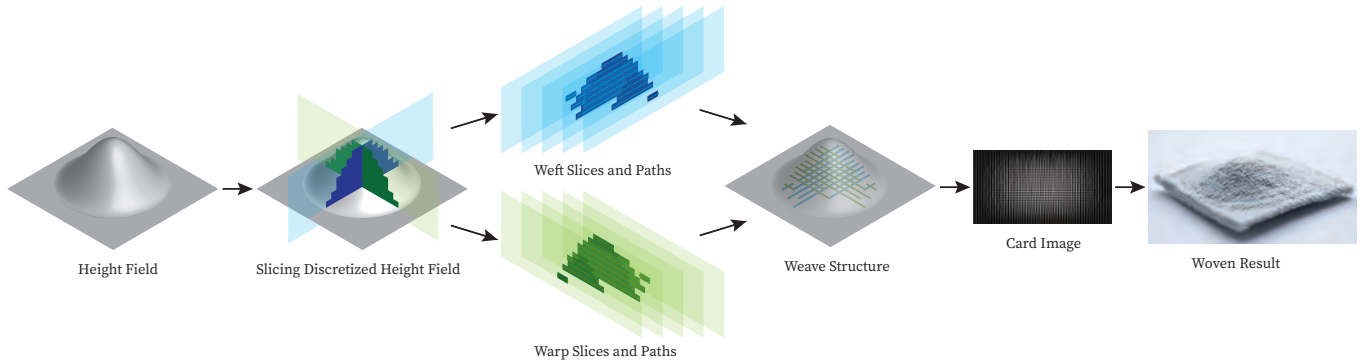

Fig. 6. The Pipeline of Our Method

designed separately: to ensure the yarns interlace properly when woven, each slice is designed based on the positions at which the orthogonal slices will pass through it, and must pass through all the orthogonal slices at the correct points. Once the paths are found, it is fairly straightforward to compute the card image, which is then exported automatically. Subsequently, the woven object can be fabricated on the Jacquard loom.

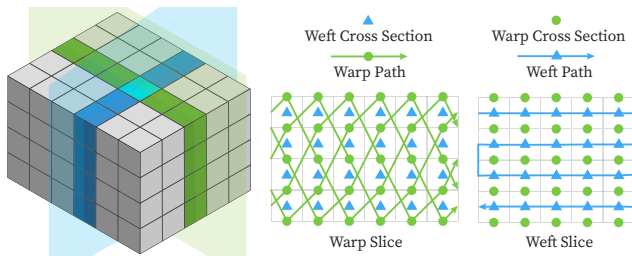

Fig. 7. **Slicing Example:** A height field is discretized into grids. The grids are then decomposed into warp slices and weft slices along the two axes respectively. Warp paths and weft paths are generated in corresponding slices to fill the space, while following the rules for weavability to hold the structure together.

Figure 7 takes a closer look at the slicing process. This example shows a solid block, *i.e.* a height field with constant value, which produces two sets of identical rectangular slices. The design task is to fill each rectangle with weft or warp yarns. In the figure, the volume to be filled is shown as an array of cells. In each vertical stack of cells, N weft yarns will pass through near the centers of the cells, and $N + 1$ warp yarns will pass through at the top and bottom faces of the cells, where N is the number of layers (4 in this illustration). In the illustrations of warp slices, we use blue triangles at the cell centers to indicate where the weft yarns pass through, and in the weft slices we use green circles on the edges between cells to indicate where warp yarns pass through.

The yarn paths need to follow some rules and constraints so that the fabric weaves successfully and holds together well. As described in Section 3.1, the warp yarns are under tension, and can only be pulled out from the creel but never wrap back in the other direction

during weaving. Therefore, in the warp slice, each warp yarn goes all the way from the left to the right, passing through one circle in each step. The shuttle carrying the weft yarn moves back and forth during weaving. In the weft slice, the weft path switches direction in each pick, connecting a row of triangles in each pass.

There are numerous ways to achieve interlacing between warps and wefts, and the patterns we use to fill the interior are all based on the structure of straight weft yarns (each insertion stays in a single layer between turnarounds) and warp yarns that travel up and down to hold the layers together. In addition, our perimeter warp and weft yarns on the surface follow a different pattern from the regular structures to form a smooth and durable surface layer. A post-processing is applied to trim excessive materials.

In the following sections, we use similar illustrations to explain how we generate weft and warp paths for an arbitrary height field.

4.2 Designing Weft Slices

Weft slices are planned in a way that is analogous to the common approach in filament-extrusion 3D printers, which lay down one or two loops of perimeter and fill the interior region by region with regular patterns. What is different about weft slice design is that the order is reversed: the interior is filled first and subsequently wrapped with a surface layer. We will discuss the process in Section 4.4.

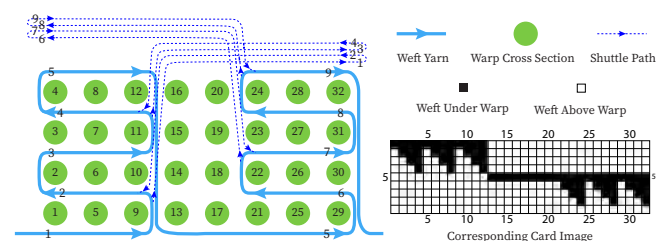

Fig. 8. Using weft turnarounds to create two separate rectangular bumps in weft slice. Each weft insertion corresponds to a row in the card image and each warp corresponds to a column, as indicated by the numbers.

The ability of shuttle weaving to turn the weft around inside the fabric, as discussed in Section 3.3, is pivotal to our algorithm

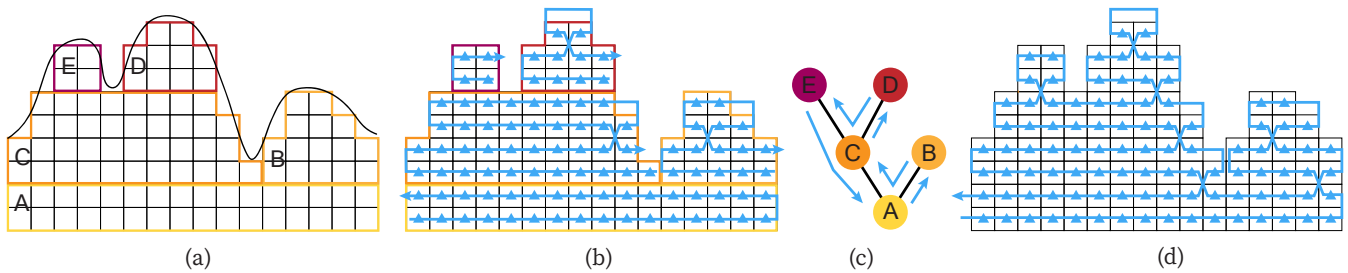

Fig. 9. **Height Field Decomposition and Weft Path:** A height field in the weft slice is discretized into grids. The grids are decomposed into several simple pieces, as indicated by different border colors in (a). In (b), weft paths are generated for each piece. A tree structure illustrates the relations between the pieces, as shown in (c). We traverse the tree recursively to connect the paths in all pieces and create a continuous weft path in (d).

for filling the interior of an arbitrary slice. For slices with a single local maximum in height, the weft path planning is straightforward: turn around progressively farther from the edges to make each layer shorter than or equal to the one below. For weft slices with multiple local maxima such as a shape with multiple bumps, this is nontrivial but still feasible, as early turnarounds can be done anywhere regardless of potential obstructing material. Figure 8 illustrates the weft path for a simple structure with two rectangular bumps. For example, during the weaving of the right bump, the warps numbered 1–20 are kept consistently in the down position. Upon the insertions of wefts 6 and 8, the shuttle travels all the way to the left in order to clear the reed while pressing the new weft yarns into place. When it goes back to the right, the loose yarn is pulled back to where it catches on warp ends 22 and 24. The path of the loose yarn lies above the previously woven left bump, so that the previous woven pattern remains undisturbed. While the path shown in this example is simpler than the one devised by our general algorithm, it illustrates the principle by which any, even non-convex, height field slice can be filled.

Our general algorithm divides the slice into simple pieces with no local minima in height, fills each piece separately, and then connects the paths to form a single continuous path for the entire slice. We use a recursive approach to fill a piece p starting from side $s \in \{\text{left, right}\}$:

- (1) Find the lowest local minimum in the height, excluding the two ends. Round down to the nearest even height, denoted h . If there is no local minimum, set h to the maximum height of p . The part of p below height h is a simple piece. Construct a path for it using the approach described below, starting from side s .
- (2) Divide the part of the slice above the height h into components, cutting at each local minimum that occurs at height h or $h + 1$.
- (3) For each of the child components, recursively generate a yarn path starting from the same side as the top yarn in the parent. Join each child path into the parent path by cutting the top yarn as close as possible to the starting point of the child path, and connect the loose ends produced to the ends of the child path in the unique way that keeps the direction consistent.

The result is a yarn path that starts and ends on side s . This procedure requires a method to fill a simple piece p starting from side s :

- (1) Round the height of p up to an even number h .
- (2) Starting from layer 0 (the bottom layer) of p , on side s , travel horizontally until there is no warp yarn at the top of the next cell. Move up two layers and repeat, traveling back towards side s . Repeat this until the next yarn would be at a height $\geq h$. Label this yarn path y_1 .
- (3) Follow the procedure of step (1) starting from layer 1 on side s . Label this path y_2 . It will end on the same side as y_1 , one layer above.
- (4) Extend y_1 up one layer and across to meet the end of y_2 . Reverse y_2 and join it with y_1 . The single resulting path starts on layer 0 on side s and ends on layer 1 on side s .

These procedures are easiest to understand with examples. Figure 10(a) illustrates filling a simple piece, and Figure 9 illustrates how the recursive algorithm divides a complex slice into several pieces, shows the separate paths generated for the individual pieces, and finally shows how the paths are joined into a single complete path.

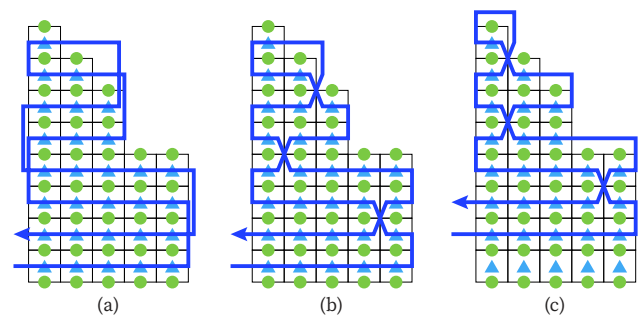

Fig. 10. **Selvedge:** (a) A simple piece of a weft slice is filled with a weft yarn that moves back and forth. The weft moves up for two layers every pick until the top and then moves down for two layers every pick. (b) The wefts at the two sides are rearranged so that every other warp is wrapped by one turnaround. (c) Starting from layer 1 rather than layer 0 in (b), a different set of warp are wrapped. Alternating (b) and (c) creates a regular pattern on the selvedge surface for through-thickness and plain layer-to-layer warp structures.

This path planner as described generates *selvedges*—the surfaces on the sides of the material where the wefts turn around (See Figure 14). As shown in Figure 10 (a), each weft pick wraps two layers of warps, resulting in some warps wrapped by two wefts while others not wrapped at all. This will create loose weft segments at the selvedge surface, which is undesirable. To create a nicer selvedge, we apply a post-processing to the path at the sides: we swap the two wefts across the warp that is wrapped by two turnarounds, so that every other warp is wrapped by one weft turnaround, as shown in Figure 10 (b). For the angled layer-to-layer structure, wrapping around warps at the same height in different weft slices is desired, because each warp yarn travels up or down by one layer in each step, so that every warp will be wrapped somewhere. However, for the other two warp structures where each warp yarn travels up or down by two layers in each step, this will leave some warps that are not wrapped anywhere, resulting in them falling apart from the structure. So in this case, we start at layer 1 rather than layer 0 every other slice, leaving layer 0 to be contained by the surface weave on the bottom surface, as shown in (c). Weft slices of (b) and (c) alternate so that all warps will be wrapped in the through-thickness and plain layer-to-layer structures.

4.3 Designing Warp Slices

For warp yarns, we apply three types of patterns that are generalized from the three structures introduced in Section 3.2. As with the weft slices, we generate these volumetric patterns to fill the interior, and add additional yarns to form a surface layer (Section 4.4).

The two layer-to-layer structures are simplest: we use exactly the warp paths that would be used to weave a solid full-height block. When the paths exit the surface, they do not interlace with any weft and are therefore relaxed to straight yarns floating over the surface. The approach is illustrated in Figure 11.

The through-thickness angle interlock structure requires a different design, since using the same design would lead to numerous short, hard-to-trim floating warp yarns. The key feature of the through-thickness structure in a regular block is that the warp yarns travel diagonally through the weft grid from one surface of the fabric to the other, creating a lattice-like architecture in which the weft yarns lie at the center of each quadrilateral. We devise a simple algorithm, illustrated in Figure 12, to generate paths that form a lattice like this:

- (1) Create a lattice of yarn segments traveling at a 2:1 slope on both diagonals through the grid of weft yarns, ending at the points where they encounter the top or bottom surface of the slice.
- (2) At the top surface, for every negative-sloping end (colored light green in the figure) that has a positive-sloping end (dark green) in the column immediately to its left, connect the ends.
- (3) At the bottom surface, for every positive-sloping (dark green) end that has a negative-sloping (light green) end in the column immediately to its left, connect the ends.
- (4) For non-rectangular slices, some free ends will remain. Connect each to the nearest available loose end, starting from the lowest heights and progressing upwards.

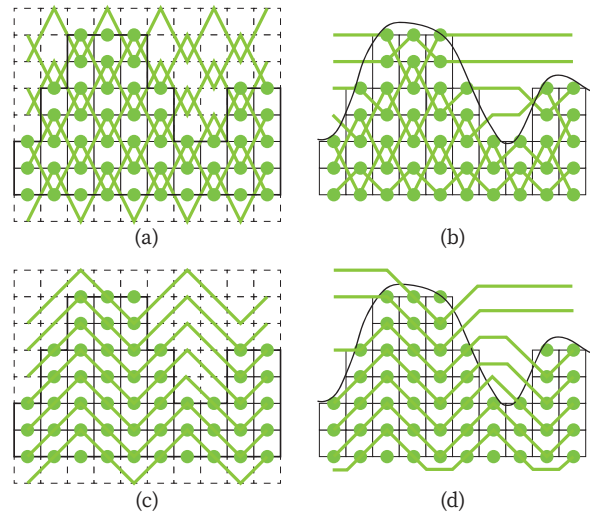

Fig. 11. **Variants of Layer-to-layer Structure:** (a) and (b) show the plain layer-to-layer structure, in which each warp yarn goes up and down by two layers. (c) and (d) show the angled layer-to-layer structure, in which each warp yarn goes up and down by two layers in a 45 degree diagonal. For an arbitrary height field, the warp paths are generated as if there is a full grid ((a) and (c)). The parts above the height field surface are relaxed to be straight because there are no weft yarns that interlace with them ((b) and (d)).

The above procedure creates the standard pattern when applied to rectangular warp slices, and creates material with similar structure to fill irregular volumes below complex height fields. An important feature here is that when the surface has a slope in the warp direction, the warp yarns will exit the surface, which are analogous to the support material in 3D printing and need to be trimmed from the finished object. The surface layer described in the next section is crucial for holding the ends in place and making the warp trimming easier.

4.4 Surface Layer

As mentioned in Section 4.3, the portions of the warp yarns above the top surface of the target height field will be trimmed during post-processing. In order to hold the cut ends in place and maintain the stability of the structure, an extra layer consisting of continuous weft and warp yarns is added on the top surface. The top surface layer is created using one extra weft and two extra warps, as illustrated in Figure 13:

- (1) In each weft slice, after going through the designated weft paths in the structure, the weft yarns go under the bottom layer from the left all the way to the right, and then go up and wrap back across the top surface.
- (2) At the positions where the height drops or climbs for a number of layers greater than some threshold (8 layers), the top weft yarn is moved down to the height right above its lowest neighbor, so that the cliff selvedge is revealed.
- (3) A warp yarn (dark green) is added on the top surface, which alternates between going above the top weft, including the

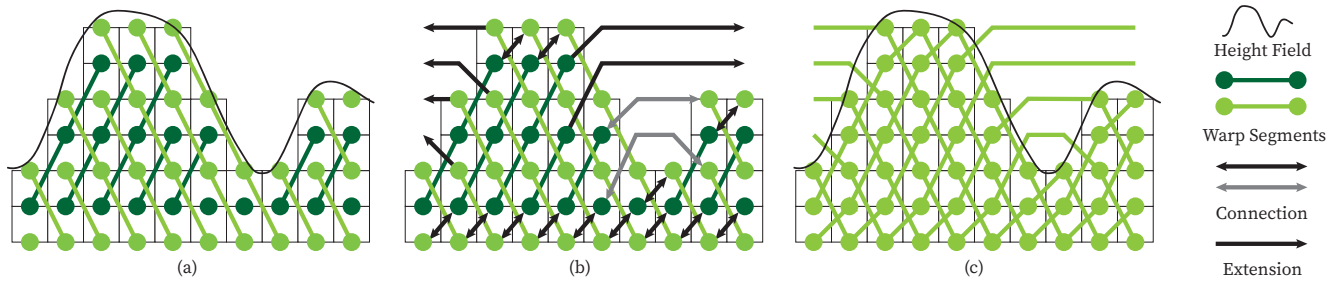

Fig. 12. **A Variant of Through-thickness Structure:** (a) A height field is discretized in to grids. Two sets of diagonal segments are generated to connect the circles. (b) First, the light green circles on the surface are connected to the dark green circles next to them (black double arrows). Then, the free ends of segments in the concave part of the height field are paired and connected (gray double arrow). Finally, the rest of the free ends are extended to the two sides of the slice (black single arrow). (c) The connected and extended segments form the paths for the warp yarns. The part above the height field surface will be trimmed in post-process.

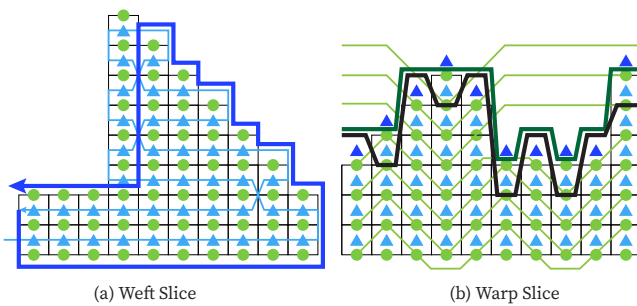

Fig. 13. **Surface Layer:** (a) After finishing the main path (light blue) in each weft slice, two weft picks (dark blue) are added to wrap around the whole surface. The new path is hidden inside for vertical cliffs above a certain threshold. (b) Two warp yarns are added. One (dark green) interacts with the top wefts, creating a plain weave pattern on the surface. The other (black) binds the surface plain weave with the main structure. Floating warps (light green) outside of the surface will be trimmed and the continuous surface holds the structure inside.

one added in (1), and going under the top weft in the next step, to create a plain weave pattern on the surface.

- (4) Another warp yarn (black) is added, and alternates between going above the top weft and going under the second highest weft to create a layer-to-layer style path that binds the surface and the main structure.

5 RESULTS

Loom and yarn. All the results in this paper were woven on a customized loom with a Jacquard head made by Staubli. The loom has a total of 2688 hooks that are arranged into 112 columns with 24 warps per column. The reed density is 1.34 mm per dent. We use 50 active dents in the middle of the reed, each with 24 warp yarns. Therefore, we can produce a fabric that is 50 columns (around 67 mm) wide, 24 warp layers thick, and arbitrarily long. The dimensions of the fabric may change after being removed from the loom and relaxed from the tension and such changes also depend on the weave structure. All the results were woven with an advance of 1.55mm per weft slice. The yarn we used for both warp and weft is

a multifilament unspun polyester yarn with light tack, supplied by Unifi. The diameter of the yarn is 0.37 mm and the weight is 1000 denier (0.11 grams/meter).

Warp extrusions. Figure 14 shows several samples that have constant weft slices (extrusions in the warp direction). Warp extrusions are the simplest case because the weft paths in each slice are the same, and each warp slice is a rectangle. Therefore, no warp yarn will go out of the surface and no trimming is needed. We use warp extrusion samples as simple test cases. These samples all use the angled layer-to-layer structure, which creates the most thickness in practice. Samples P1 and P2 show a comparison of selvages at the steep cliff in the weft slice. The plain weave surface smooths out the cliff edge (sample P1) and creates long loose yarns, so we move the weft inside the surface and reveal the selvage face (sample P2), which creates a shape cliff edge. Samples P3 and P4 demonstrate warp extrusions with two other cross section shapes, where P3 has a single triangular bump and P4 has two square bumps.

2D height fields. Figure 15 demonstrates a set of more complicated 3D shapes, in which both the woven samples and corresponding manually generated height fields are shown. We tested the three warp structures, and found that the plain layer-to-layer and through-thickness structures tend to create a dense rigid material with less thickness, while the angled layer-to-layer structure tends to create thicker and softer material. In Figure 15, all samples except the diamonds and SIGGRAPH patterns use angled layer-to-layer warps to achieve the most bulkiness. The diamonds pattern uses through-thickness warps and the SIGGRAPH pattern uses plain layer-to-layer warps, both of which create rigid shallow reliefs that preserve the shapes well. The diamonds and SIGGRAPH height fields are generated by filtering sharp original images, so the edges between the pattern and background are smoothed to keep the slope in the warp direction within limit (Section 6).

The running time of our algorithm on an ordinary laptop and the weaving time for each of the samples are shown in Table 1.

Post-processing. The trimming was done manually by one person with ordinary scissors and was not timed strictly. The trimming time varied from shape to shape: Warp extrusions did not need trimming,

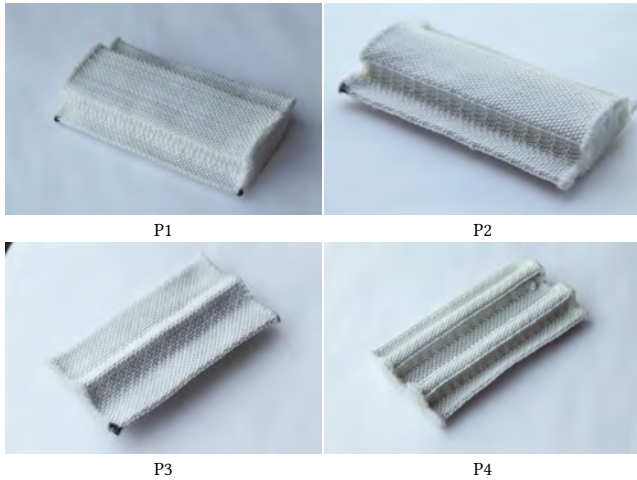

Fig. 14. **Warp Extrusion Samples:** P1 and P2 are generated from the same height field. The loose yarns in P1 are moved inside the fabric in P2, creating a neat pattern and sharp cliff on the selvedge face. P3 shows a triangular bump. P4 shows double square bumps.

Table 1. **Running Time of Our Algorithm and Weaving Time**

Sample	# picks	Running Time [s]	Weaving Time [min]
Gaussian bump	584	0.20	8.34
pyramid	560	0.22	8.00
bunny	1162	0.36	16.60
teapot	1468	0.44	20.97
diamonds	6444	1.36	92.06
SIGGRAPH	8658	2.30	123.69

simple shapes (Gaussian/pyramid/teapot) took around 10 minutes to trim, while large, complex examples (diamonds/SIGGRAPH) took several hours. Analogous to removing the support material in 3D printing, the effort needed to trim the extra warp largely depended on the material type, the shape, and the warp paths. The unspun polyester yarn we used turned out to be particularly hard to trim because it created a lot of puffy fibers upon being cut, while common cotton yarns could be easier to trim. Shapes with deep and narrow valleys in the warp slice were harder to trim (e.g. the SIGGRAPH example) because they created short floating warp segments between the small gaps.

6 CONCLUSION

In this work, we present a method to generate 3D weave structures automatically for an arbitrary height field input. Our method works similarly to the slicing and path generation software in layer-by-layer 3D printing. The height field is sliced in the two axes corresponding to the warp and weft directions. Warp and weft yarn paths are generated respectively in the slices and are then combined to create the weave structure. The card image is automatically generated for the weave structure and can be woven on a Jacquard loom. As demonstrated by a range of results, the 3D woven samples generated with our method can approximate quite complicated inputs.

Limitations and future work. Our method has several limitations, which could lead to interesting future development. In theory, our algorithm can generate weavable paths for any height field. However, steep slopes in the warp direction cannot be well-preserved due to the nature of weaving: The warp yarns are always under tension in the same direction and cannot wrap back. Therefore, we limit the slope in warp slices to no greater than 8 layers per weft slice in practice. This limit does not apply to weft slope because of the wraparound mechanism. Another factor that limits the shape we can produce in practice is the trimming process: Shapes with very small steep gaps in warp slices can be very hard to trim, so such input height fields are avoided in our results.

Our woven results contain reconstruction errors due to the deformable nature of yarns and our geometric-modeling based approach, as well as the discretization process. The errors depend on the mechanical properties of the yarns, loom setup, and weave structure. The complicated interactions between the yarns may cause them to deviate from where they are supposed to be in the geometric model. For example, the edges and corners can be smoothed. Also, when the fabric is removed from the loom, it usually shrinks in the warp direction as the tension vanishes, causing errors in the aspect ratio. Future development will involve quantifying the errors, calibrating the loom settings, and adjusting the weave structure for more accurate reconstruction of the shape. Physically-based simulation [Cirio et al. 2014, 2015; Kaldor et al. 2008; Leaf et al. 2018] can be used to predict the result of the woven structure, and may further be used to optimize the structure and improve the results.

As the first step in transforming a loom into a “3D printer”, our work focuses on height field input. Future exploration may try to fabricate more general 3D shapes. For example, it is possible to create cavities in the fabric by having separate layers, which may be used to contain embedded devices.

Finally, manually trimming the fabric is a tedious process. While our work exhibits an initial demonstration of this fabrication technique, its application can drive future development of more efficient solutions for post-processing, such as path-based robotic trimming.

ACKNOWLEDGMENTS

We would like to acknowledge the management of T.E.A.M. Inc. (teamtextiles.com) for supporting the project through access to their advanced 3D weaving facility in Woonsocket, RI, as well as expert technical assistance. We thank Emily Holtzman for permission to use Figure 3. We thank the support from the RISD Virtual Textile Research Group. We also thank Doug James, Jonathan Leaf, Xinru Hua, and Ante Qu for valuable discussions, and Eston Schweickart for yarn rendering code. This work is funded by the National Science Foundation under grants IIS-1513954, IIS-1513967 and IIS-1644523, and by generous donations from Under Armour.

REFERENCES

- Lea Albaugh, Scott Hudson, and Lining Yao. 2019. Digital Fabrication of Soft Actuated Objects by Machine Knitting. In *Proceedings of the 2019 CHI Conference on Human Factors in Computing Systems*. ACM, 184.
- Xiaogang Chen, Lindsay Waterton Taylor, and Li-Ju Tsai. 2011. An overview on fabrication of three-dimensional woven textile preforms for composites. *Textile Research Journal* 81, 9 (2011), 932–944.
- Gabriel Cirio, Jorge Lopez-Moreno, David Miraut, and Miguel A. Otaduy. 2014. Yarn-Level Simulation of Woven Cloth. *ACM Trans. on Graphics (Proc. of ACM SIGGRAPH)*

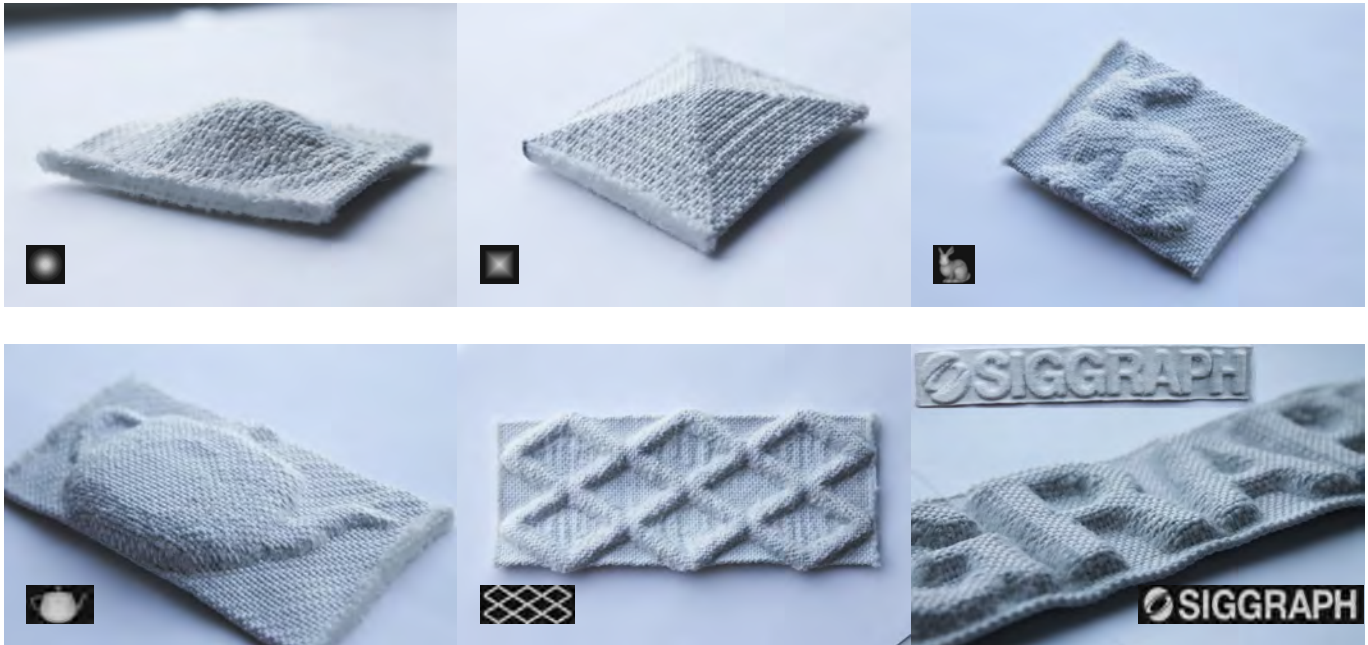

Fig. 15. Fabrication Results

- Asia) 33, 6 (2014). <http://www.gmr.v.es/Publications/2014/CLMO14>
- Gabriel Cirio, Jorge Lopez-Moreno, and Miguel A Otaduy. 2015. Efficient simulation of knitted cloth using persistent contacts. In *Proceedings of the 14th ACM SIGGRAPH/Eurographics Symposium on Computer Animation*. ACM, 55–61.
- Cura. 2011. Cura. <https://ultimaker.com/en/products/cura-software>.
- Donghong Ding, Zengxi Stephen Pan, Dominic Cuiuri, and Huijun Li. 2014. A tool-path generation strategy for wire and arc additive manufacturing. *The international journal of advanced manufacturing technology* 73, 1-4 (2014), 173–183.
- Rajeev Dwivedi and Radovan Kovacevic. 2004. Automated torch path planning using polygon subdivision for solid freeform fabrication based on welding. *Journal of Manufacturing Systems* 23, 4 (2004), 278–291.
- GmbH EAT. 2015. 3DWeave | EAT GMBH - The Designscope Company. <http://designscopecompany.com/3dweave/>
- Mikhaila Friske, Shanel Wu, and Laura Devendorf. 2019. AdaCAD: Crafting Software For Smart Textiles Design. In *Proceedings of the 2019 CHI Conference on Human Factors in Computing Systems*. ACM, 345.
- Ruben Geerincq, Ives De Baere, Geert De Clercq, Jan Ivens, and Joris Degrieck. 2016. Development and characterization of composites consisting of woven fabrics with integrated prismatic shaped cavities. In *3D fabrics and their applications*.
- M Gopi and David Eppstien. 2004. Single-strip triangulation of manifolds with arbitrary topology. In *Computer Graphics Forum*, Vol. 23. Wiley Online Library, 371–379.
- Claire Harvey, Emily Holtzman, Joy Ko, Brooks Hagan, Rundong Wu, Steve Marschner, and David Kessler. 2019. Weaving objects: spatial design and functionality of 3D-woven textiles. In *ACM SIGGRAPH 2019 Art Gallery*. ACM, 5.
- Martin Held and Christian Spielberger. 2014. Improved spiral high-speed machining of multiply-connected pockets. *Computer-Aided Design and Applications* 11, 3 (2014), 346–357.
- Jonathan M. Kaldor, Doug L. James, and Steve Marschner. 2008. Simulating Knitted Cloth at the Yarn Level. *ACM T. Graph. (SIGGRAPH'08)* 27, 3 (2008), 65.
- Alexandre Kaspar, Liane Makatura, and Wojciech Matusik. 2019. Knitting Skeletons: A Computer-Aided Design Tool for Shaping and Patterning of Knitted Garments. *arXiv preprint arXiv:1904.05681* (2019).
- Jonathan Leaf, Rundong Wu, Eston Schweickart, Doug L James, and Steve Marschner. 2018. Interactive design of periodic yarn-level cloth patterns. In *SIGGRAPH Asia 2018 Technical Papers*. ACM, 202.
- James McCann, Lea Albaugh, Vidya Narayanan, April Grow, Wojciech Matusik, Jennifer Mankoff, and Jessica Hodgins. 2016. A compiler for 3D machine knitting. *ACM Transactions on Graphics (TOG)* 35, 4 (2016), 49.
- AP Mouritz, MK Bannister, PJ Falzon, and KH Leong. 1999. Review of applications for advanced three-dimensional fibre textile composites. *Composites Part A: Applied science and manufacturing* 30, 12 (1999), 1445–1461.
- MultiMechanics. 2018. Product. <http://multimechanics.com/product/>
- Vidya Narayanan, Lea Albaugh, Jessica Hodgins, Stelian Coros, and James McCann. 2018. Automatic Machine Knitting of 3D Meshes. *ACM Trans. Graph.* 37, 3, Article 35 (Aug. 2018), 15 pages. <https://doi.org/10.1145/3186265>
- Vidya Narayanan, Kui Wu, Cem Yuksel, and James McCann. 2019. Visual knitting machine programming. *ACM Transactions on Graphics (TOG)* 38, 4 (2019), 1–13.
- Huaishu Peng, Jennifer Mankoff, Scott E Hudson, and James McCann. 2015. A layered fabric 3D printer for soft interactive objects. In *Proceedings of the 33rd Annual ACM Conference on Human Factors in Computing Systems*. ACM, 1789–1798.
- Pointcarre. 1988. Pointcarre. <http://www.pointcarre.com/>.
- Ivan Poupyrev, Nan-Wei Gong, Shiho Fukuhara, Mustafa Emre Karagozler, Carsten Schwesig, and Karen E Robinson. 2016. Project Jacquard: interactive digital textiles at scale. In *Proceedings of the 2016 CHI Conference on Human Factors in Computing Systems*. ACM, 4216–4227.
- ScotWeave. 2019. ScotWeave. <http://www.scotweave.com/>.
- Martin Sherburn. 2007. *Geometric and mechanical modelling of textiles*. Ph.D. Dissertation. University of Nottingham.
- Slic3r. 2013. Slic3r. <http://www.slic3r.org/>.
- Muhammad Umair, Yasir Nawab, Mumtaz Hasan Malik, and Khubab Shaker. 2015. Development and characterization of three-dimensional woven-shaped preforms and their associated composites. *Journal of Reinforced Plastics and Composites* 34, 24 (2015), 2018–2028.
- Josh Vekhter, Jiacheng Zhuo, Luisa F Gil Fandino, Qixing Huang, and Etienne Vouga. 2019. Weaving geodesic foliations. *ACM Transactions on Graphics (TOG)* 38, 4 (2019), 1–22.
- Kui Wu, Hannah Swan, and Cem Yuksel. 2019. Knittable stitch meshes. *ACM Transactions on Graphics (TOG)* 38, 1 (2019), 10.
- Joanne Yip and Sun-Pui Ng. 2008. Study of three-dimensional spacer fabrics: Physical and mechanical properties. *Journal of materials processing technology* 206, 1-3 (2008), 359–364.
- Minjing Yu, Zipeng Ye, Yong-Jin Liu, Ying He, and Charlie CL Wang. 2019. Lineup: Computing chain-based physical transformation. *ACM Transactions on Graphics (TOG)* 38, 1 (2019), 1–16.
- Jiahua Zhang, George Baciu, Shuang Liang, and Cheng Liang. 2010. A creative try: Composing weaving patterns by playing on a multi-input device. In *Proceedings of the 17th ACM Symposium on Virtual Reality Software and Technology*. ACM, 127–130.
- Haisen Zhao, Fanglin Gu, Qi-Xing Huang, Jorge Garcia, Yong Chen, Changhe Tu, Bedrich Benes, Hao Zhang, Daniel Cohen-Or, and Baoquan Chen. 2016. Connected fermat spirals for layered fabrication. *ACM Transactions on Graphics (TOG)* 35, 4 (2016), 100.